

Wireless Racing Wheel Apex  
for PlayStation®5 consoles, PlayStation®4 consoles, and Windows® PC\*

# Instruction Manual

Thank you for purchasing this product.  
Before using this product, please read the instructions carefully.  
After reading the instruction manual, please keep it for reference.

\*PC compatibility not tested nor endorsed by Sony Interactive Entertainment.



## Table of Contents

Quick Start Guide .....	2-3	Adjustable Dead Zone .....	11
Caution .....	3	Adjustable Sensitivity - Steering .....	12
Contents .....	4	Adjustable Sensitivity - Foot Pedals .....	13
Compatibility .....	4	Quick Handling Mode .....	14
Layout and Features .....	5	Adjustable Sensitivity / Adjustable Dead Zone / Quick Handling Mode Reset Back to Default Settings .....	14
How to Set Up .....	6-7	App [HORI Device Manager Vol.2] .....	15
▸ Steering Unit		Troubleshooting .....	15
▸ Foot Pedal		Regarding Wireless Interference .....	16
How to Connect .....	8-9	Regarding Battery .....	16
How to Charge .....	9	Specifications .....	17
Assign Mode .....	10		



### ◀ Compatible Software

<https://stores.horiusa.com/spf-022U/compatibility/>



# Quick Start Guide



Before using this product, please read the instructions carefully.

- Please check that your console is updated to the latest system software.

## PS5® console

1. Select "Settings" → "System".
2. Select "System Software" → "System Software Update and Setting". If a new update is available, "Update Available" will be displayed.
3. Select "Update System Software" to update the software.

## PS4™ console

1. Select "Settings" → "System Software Update".
2. If a new update is available, follow the steps as shown on the screen to update the software.

- Please charge this product.      How to Charge ⇒ **p.9**

# 1

Mount the steering unit onto a flat, stable surface.

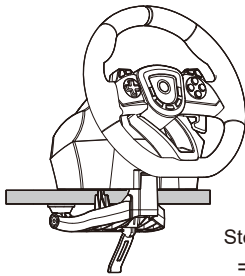

Steering Unit  
⇒ **p.6-7**

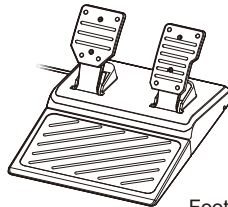

Foot Pedal  
⇒ **p.7**

# 2

Set the Hardware Toggle Switch and Mode Toggle Switch to the appropriate setting.

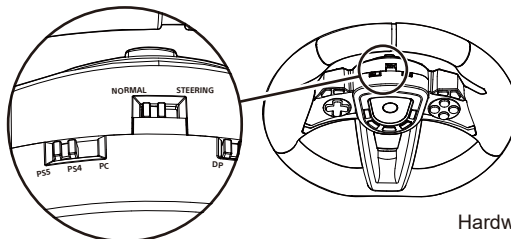

Hardware and Mode Settings  
⇒ **p.8**

### 3 Connect all cables and receiver as follows.

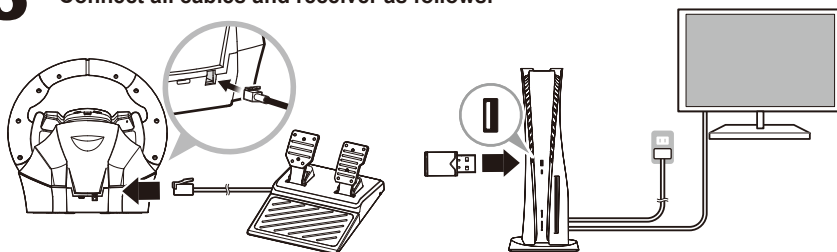

### 4 Turn the console on and press the (PS) button on the racing wheel. Then log-in with the racing wheel.

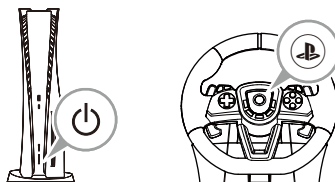

### 5 Turn the steering wheel fully to the right, then fully to the left. Press down fully on the L pedal and R pedal one at a time. This ensures proper wheel calibration.

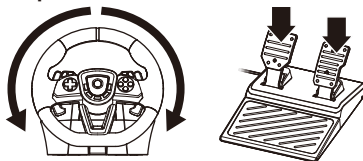

How to Connect  
⇒ p.8



## Caution

**Parents / Guardians:**  
**Please read the following information carefully.**

- This product contains small parts. Keep away from children under 3 years old.
- Keep this product away from small children or infants. Seek medical attention immediately if any small parts are swallowed.
- Long cord. Strangulation hazard.
- Keep the product away from dusty or humid areas.
- Do not use this product if it has been damaged or modified.
- Do not get this product wet. This may cause an electric shock or malfunction.
- Do not place this product near heat sources or leave under direct sunlight for an extended period. Overheating may cause malfunction.
- Do not use this product with a USB hub or extension cable. The product may not function properly.
- Do not insert the modular plug into socket-outlets.
- Do not touch the metal parts of the USB plug.
- Do not apply strong impact or weight on the product.
- Do not pull roughly or bend the cable of the product.
- Do not disassemble, modify or attempt to repair this product.
- If product needs cleaning, use only a soft dry cloth. Do not use any chemical agents like benzene or thinner.
- The packaging must be retained since it contains important information.
- Please retain this instruction manual for your future reference.
- The normal function of the product may be disturbed by strong electro-magnetic interference. If so, simply reset the product to resume normal operation by following the instruction manual (How to Connect). In case the function does not resume, please relocate to an area which does not have electro-magnetic interference to use the product.
- Do not use this product for anything other than its intended purpose. We are not responsible for any accidents or damages in the event of use other than the intended purpose.
- Keep your fingers away from the foot pedals during gameplay.

## Contents

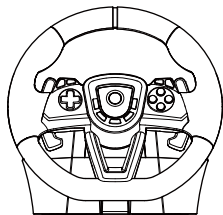

Steering Unit × 1

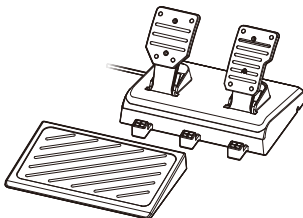

Foot Pedal × 1

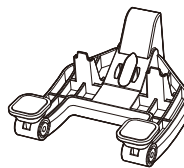

Clamp × 1



Screw × 1



Receiver × 1

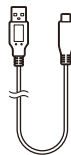

USB Cable  
(USB-A to USB-C™) × 1

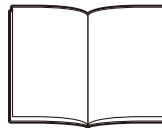

Instruction Manual × 1

## Compatibility

### PlayStation®5 console, PlayStation®4 console

#### Important

Before using this product, please read the instruction manuals for the software and console hardware to be involved in its use.

Please check that your console is updated to the latest system software.

An internet connection is required to update the PS5® console and PS4™ console to the latest system software.

HORI has conducted wireless testing and verified this product with the PS5® CFI-1000 & CFI-2000 series. If there is an issue related to wireless connectivity, it is an issue with the HORI controller. Please contact HORI customer support for assistance.

For PS5® CFI-1000 series, we recommend inserting this product's receiver into the PS5® console's front USB port. For reference: <https://www.playstation.com/en-us/support/hardware/ps5-usb-ports-guide/>

### PC\*

\*PC compatibility not tested nor endorsed by Sony Interactive Entertainment.

Supported OS	Windows® 11 / 10
Input Method	XInput
System Requirements	USB-A Port

Functions as PC controller through XInput. This product does not support DirectInput.

# Layout and Features

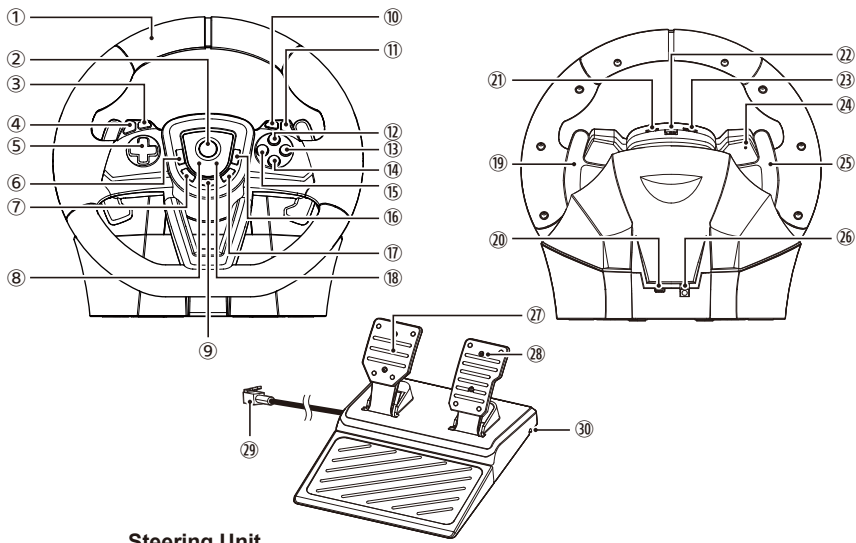

## Steering Unit

① ... Steering Wheel [PS5®, PS4™ Steering Mode] Steering [PS5®, PS4™ Normal Mode] L Stick X Axis	[PC] L Stick X Axis
② ... [PS5®, PS4™] (PS) button	[PC] HOME button
③ ... [PS5®, PS4™] L1 button	[PC] LB button
④ ... [PS5®, PS4™] L2 button	[PC] LT button
⑤ ... [PS5®, PS4™] Directional buttons	[PC] Left Stick button
⑥ ... [PS5®, PS4™] L3 button	[PC] BACK button
⑦ ... [PS5™] \   / (create) button [PS4™] SHARE button	[PC] START button
⑧ ... LED (L)	
⑨ ... ASSIGN button	
⑩ ... [PS5®, PS4™] R1 button	[PC] RB button
⑪ ... [PS5®, PS4™] R2 button	[PC] RT button
⑫ ... [PS5®, PS4™] △ button	[PC] Y button
⑬ ... [PS5®, PS4™] ○ button	[PC] B button
⑭ ... [PS5®, PS4™] × button	[PC] A button
⑮ ... [PS5®, PS4™] □ button	[PC] X button
⑯ ... [PS5®, PS4™] R3 button	[PC] Right Stick button
⑰ ... [PS5™] ≡ (options) button [PS4™] OPTIONS button	
⑱ ... LED (R)	

## Steering Unit (Back View)

⑲ ... R paddle [PS5®, PS4™ Normal Mode] R1 button [PS5®, PS4™ Steering Mode] R1 paddle	[PC] X button
--	---------------

⑳ ... USB-C™ Connector	
㉑ ... Directional buttons Toggle Switch	
㉒ ... Mode Toggle Switch	
㉓ ... Hardware Toggle Switch	
㉔ ... Reset button	
㉕ ... L paddle [PS5®, PS4™ Normal Mode] L1 button [PS5®, PS4™ Steering Mode] L1 paddle	[PC] A button
㉖ ... Foot Pedal Connection	

## Foot Pedal

㉗ ... L pedal [PS5®, PS4™ Normal Mode] L2 button [PS5®, PS4™ Steering Mode] Brake	[PC] LT button
㉘ ... R pedal [PS5®, PS4™ Normal Mode] R2 button [PS5®, PS4™ Steering Mode] Accelerate	[PC] RT button
㉙ ... Modular Plug	
㉚ ... Cable Groove	

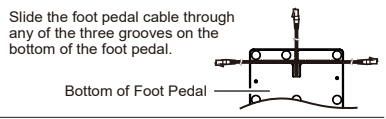

Bottom of Foot Pedal

# How to Set Up

## Steering Unit

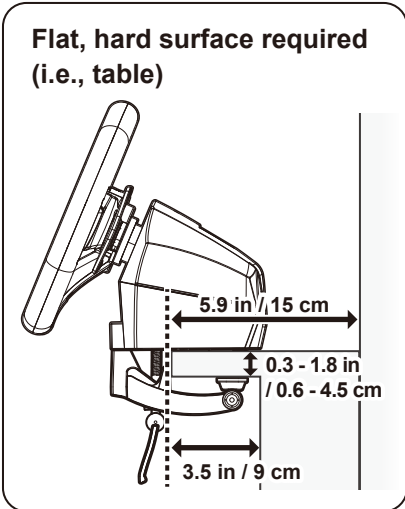

**1** Put the screw through the clamp.

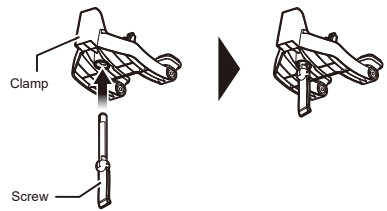

**2** Put the clamp through the hole on the bottom of the steering unit. Rotate the screw clockwise to secure temporarily.

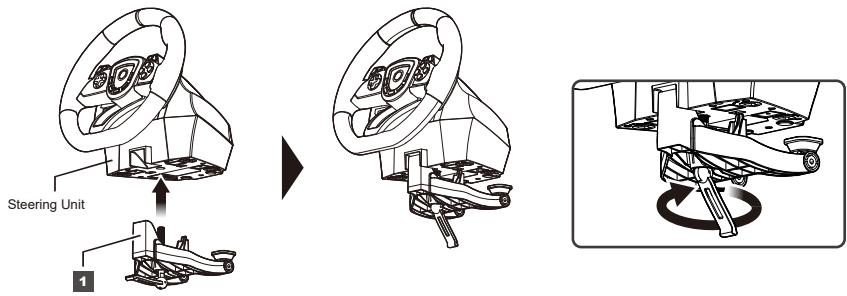

3

Place the base of the steering unit securely on the mounting surface, ensuring the clamp is in place.

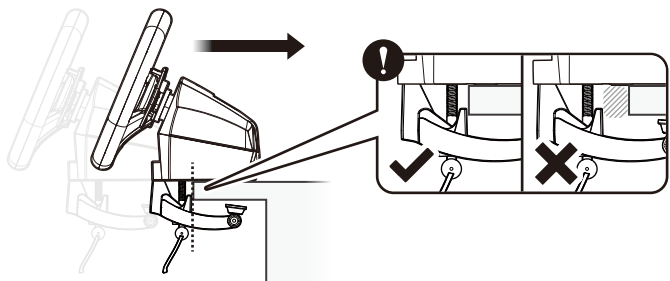

4

Rotate the clamp shaft clockwise while holding the steering wheel unit to secure in place.



### ■ Foot Pedal

Assemble the foot pedal as shown in the diagram.

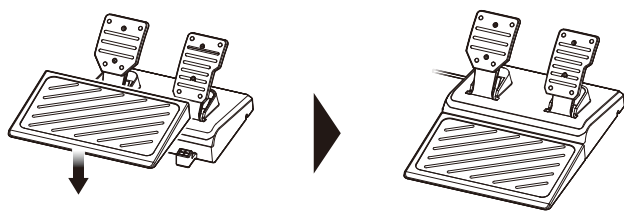

#### Cable Groove

Slide the foot pedal cable through any of the three grooves on the bottom of the foot pedal.

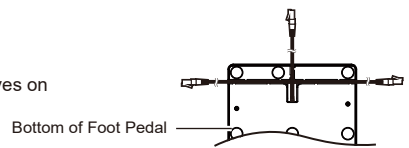

# How to Connect

1

Connect the foot pedal's modular plug to the steering unit's foot pedal connection port.

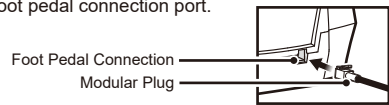

2

Set the toggle switches to the appropriate setting (see below).

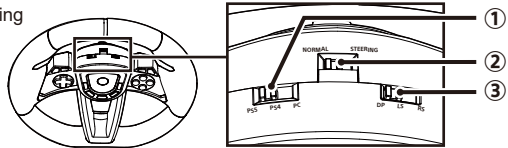

## 1 Hardware Toggle Switch

Set based on hardware.



PS5<sup>®</sup> console

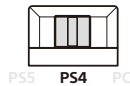

PS4<sup>™</sup> console



PC

## 2 Mode Toggle Switch

- When using with PS5<sup>®</sup> console or PS4<sup>™</sup> console, the appropriate setting of the Mode Toggle Switch will depend on the software that the product is used with.
- When using with PC, Mode Toggle Switch can be set to either setting.

Switch between Steering Mode and Normal Mode.

- Steering Mode ..... Response of steering wheel and pedals are more realistic in Steering Mode. Some software titles do not support Steering Mode.
- Normal Mode ..... Please use Normal Mode when software title is not compatible with Steering Mode.

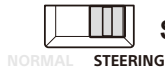

Steering Mode



Normal Mode

## 3 Directional buttons Toggle Switch

- This function can be switched on only when used with PS5<sup>®</sup> console and PS4<sup>™</sup> console.
- The Directional buttons Toggle Switch function is not available when using with PC.

Directional buttons controls can be set to directional buttons, left stick, or right stick controls.

- Directional buttons cannot be set to analog functionality.
- The Directional buttons Toggle Switch may not be compatible with some software titles. Please refer to the software's instruction manual for further information.

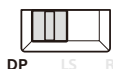

Directional buttons

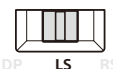

Left stick

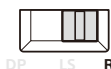

Right stick



3

Connect the receiver to the PS5® console, PS4™ console, or PC.

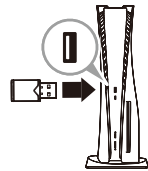



### Please follow the instructions below to avoid malfunction.

- Please check the direction of the receiver carefully before connecting.
- The steering unit and the receiver are paired by default.
- Please note that if multiple units of this product are purchased, each receiver can only be paired with the steering unit that was included together.
- Do not use this product with a USB hub or extension cable.
- Do not plug / unplug the Receiver or Modular Cable during gameplay.
- Do not push any buttons or move the steering unit or pedals when doing the following:
  - When connecting the product to the PS5® console, PS4™ console, or PC
  - When turning on the PS5® console, PS4™ console, or PC
  - When waking the console from Rest Mode

4

Turn the console on and press the  (PS) button on the product, then log-in with the racing wheel.

When the connection is complete, the LED (L) will turn white.

If you have issues connecting, simultaneously press and hold the  (PS) button and  (create) button until the LED (L) turns white.

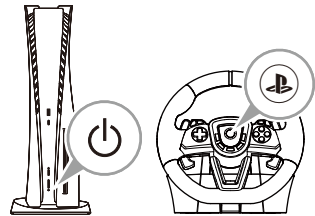

5

Turn the steering wheel fully to the right, then fully to the left. Press down fully on the L pedal and R pedal one at a time. This ensures proper wheel calibration.

Please perform this before each of the following actions:

- After connecting the product to the PS5® console, PS4™ console, or PC
- After turning on the PS5® console, PS4™ console, or PC
- After deactivating the Rest Mode

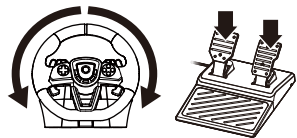

### If the steering or pedal input feels off

- Follow the directions from **4** to reconnect the steering unit and/or foot pedal.
- Please turn the steering wheel fully to the right and left one time each and press the L and R pedals one time each until they are fully pressed.

## How to Charge

Charge this product by connecting it to the USB-A port on the PS5® console, PS4™ console, or PC when power is on or in Rest Mode.

Charging Status	No battery	Low battery	Charging	Charging complete
LED (L) Status	LED Off	Blinks orange	Blinks orange slowly	LED Off

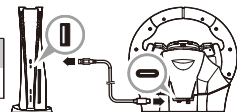

# Assign Mode





You can remap the function of buttons using this feature.

## Programmable buttons

L1 button / L2 button / L3 button / R1 button / R2 button / R3 button / L paddle / R paddle / L pedal / R pedal

## Assignable Functions

△ button / ○ button / × button / □ button / L1 button / L2 button / L3 button / R1 button / R2 button / R3 button / L pedal / R pedal / Directional buttons (Right / Down / Left / Up) / Left stick (Right / Down / Left / Up) / Right stick (Right / Down / Left / Up) / NC (Button Function Disabled)

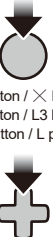
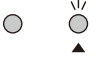
Operation	LED Status	Setting Status
<p>①</p>  <p>Hold ASSIGN button for 3 seconds</p>	 <p>LED (R) will flash slowly</p>	
<p>②</p>  <p>Press the button you want to assign</p> <p>L1 button / L2 button / L3 button / R1 button / R2 button / R3 button / L paddle / R paddle / L pedal / R pedal</p>	 <p>LED (R) will flash quickly</p>	<p><b>Start setting</b></p> <p>Button inputs are disabled during setting.</p>
<p>③</p>  <p>Push desired Assignable Function</p> <p>△ button / ○ button / × button / □ button / L1 button / L2 button / L3 button / R1 button / R2 button / R3 button / L pedal / R pedal</p> <p>Directional buttons (Right / Down / Left / Up) / Left stick (Right / Down / Left / Up) / Right stick (Right / Down / Left / Up)</p>	 <p>LED (R) is on</p>	<p><b>Finish setting</b></p> <p>! If you want to assign NC (Button Function Disabled): Press and hold the same button pressed in step 2 for 3 seconds.</p>



For example: If you want to assign the left on the directional buttons to the left stick

1. Set the Directional buttons Toggle Switch to LS. (The Directional button function is switched to the left stick.)



2. Press left on the Directional buttons



- Multiple functions cannot be assigned to a single button.
- The following buttons cannot be assigned:  
PS5® : △ (PS) button, \1/ (create) button, ≡ (options) button, ASSIGN button  
PS4™ : △ (PS) button, SHARE button, OPTIONS button, ASSIGN button
- If you do not perform step ② after ①, the LED (R) will turn off after four seconds and assignment mode will automatically end.
- When the LED (R) turns on, it indicates that a button is remapped and will stay until button function is reset to default.
- Controller settings are stored even if the PS5® console, PS4™ console, or PC is turned off or the receiver is disconnected.



## How to Reset buttons Individually

For step ③, press the same button from step ② to individually reset buttons to default.

# Adjustable Dead Zone

The dead zone play of centered wheel is adjustable to seven levels. LED (L) color will change to indicate the dead zone value.



Dead zone value	1	2	3	4	5	6	7
LED color	Green	Yellow	Red	Purple	Blue	Light Blue	White

Operation	LED Status	Setting Status
-----------	------------	----------------

<p>①</p> <p>Hold ASSIGN button for 3 seconds</p>	<p>LED (R) will flash slowly</p>	
--	----------------------------------	--

<p>②</p> <p>Press  (options) button</p>	<p>LED (R) will flash quickly</p>	<p><b>Start setting</b></p> <p>Button inputs are disabled during setting.</p>
---	-----------------------------------	---

<p>③</p> <p>Set Directional buttons Toggle Switch to DP</p> <p>DP LS RS</p>		
---	--	--

<p>④</p> <p>Dead zone value increases</p> <p>Dead zone value decreases</p>	<p>LED (L) color will change according to setting and chart above</p>	<p>Dead zone value increases by pressing up on the Directional buttons.</p> <p>Dead zone value decreases by pressing down on the Directional buttons.</p>
--	---	---

<p>⑤</p> <p>Press ASSIGN button</p>	<p>LED (L) color will change to white LED (R) will turn off</p> <p>• The LED (R) will light green when assigning buttons.</p>	<p><b>Finish setting</b></p>
-------------------------------------	---	------------------------------

- If you do not perform step ② after ①, the LED (R) will turn off after four seconds and Adjustable Dead Zone setting mode will automatically end.
- Controller settings are stored even if the PS5® console, PS4™ console, or PC is turned off or the receiver is disconnected.

# Adjustable Sensitivity - Steering

Steering wheel sensitivity is adjustable to seven levels. The LED (L) color will change to indicate the sensitivity value.

## Preferred settings

- I want to make a wide turn.
- The steering is too sensitive and difficult to maneuver.

➡ Set the sensitivity to **1** or **2**

- I want to make turn with a little steering.
- It is difficult to make a turn, or it's not turning fast enough.

➡ Set the sensitivity to **6** or **7**

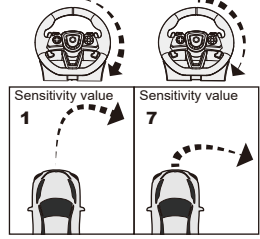

Sensitivity value	1	2	3	4	5	6	7
LED color	Green	Yellow	Red	Purple	Blue	Light Blue	White

### Operation

### LED Status

### Setting Status

①

Hold ASSIGN button for 3 seconds

LED (R) will flash slowly

②

Press  $\equiv$  (options) button

LED (R) will flash quickly

**Start setting**

Button inputs are disabled during setting.

③

Set Directional buttons  
Toggle Switch to LS

DP    **LS**    RS

④

Increase sensitivity

Decrease sensitivity

LED (L) color will change according to setting and chart above

Sensitivity value increases by pressing up on the Directional buttons.

Sensitivity value decreases by pressing down on the Directional buttons.

⑤

Press ASSIGN button

LED (L) color will change to white  
LED (R) will turn off

- The LED (R) will light green when assigning buttons.

**Finish setting**

• If you do not perform step ② after ①, the LED (R) will turn off after four seconds and Adjustable Sensitivity setting mode will automatically end.  
 • Controller settings are stored even if the PS5® console, PS4™ console, or PC is turned off or the receiver is disconnected.

# Adjustable Sensitivity - Foot Pedals

Foot pedals sensitivity is adjustable to seven levels. The LED (L) color will change to indicate the sensitivity value.



Sensitivity value	1	2	3	4	5	6	7
LED color	Green	Yellow	Red	Purple	Blue	Light Blue	White

Operation	LED Status	Setting Status
<p>①</p> <p>Hold ASSIGN button for 3 seconds</p>	<p>LED (R) will flash slowly</p>	
<p>②</p> <p>Hold the pedal that you want to change for 3 seconds</p>	<p>LED (R) will flash quickly</p>	<p><b>Start setting</b></p> <p>Button inputs are disabled during setting.</p>
<p>③</p> <p>Increase sensitivity</p> <p>Decrease sensitivity</p>	<p>LED (L) color will change according to setting and chart above</p>	<p>Sensitivity value increases by pressing up on the Directional buttons.</p> <p>Sensitivity value decreases by pressing down on the Directional buttons.</p>
<p>④</p> <p>Press ASSIGN button</p>	<p>LED (L) color will change to white LED (R) will turn off</p> <ul style="list-style-type: none"> <li>The LED (R) will light green when assigning buttons.</li> </ul>	<p><b>Finish setting</b></p>

- If you do not perform step ② after ①, the LED (R) will turn off after four seconds and Adjustable Sensitivity for Foot pedals setting mode will automatically end.
- Controller settings are stored even if the PS5® console, PS4™ console, or PC is turned off or the receiver is disconnected.

## Quick Handling Mode



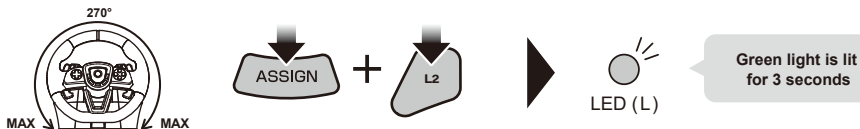

Experience quicker handling by switching the max steering output from 270 degrees to 180 degrees.



• Controller settings are stored even if the PS5® console, PS4™ console, or PC is turned off or the receiver is disconnected.



## Adjustable Sensitivity / Adjustable Dead Zone / Quick Handling Mode Reset Back to Default Settings

To simultaneously reset all of the following : Sensitivity Adjustment • Dead Zone Adjustment • Quick Handling Mode.

Operation	LED Status	Setting Status
<p>①</p>  <p>Hold ASSIGN button for 3 seconds</p>	 <p>LED (R) will flash slowly</p>	
<p>②</p>  <p>Press <math>\nabla</math> (create) button</p>	 <p>LED (R) will turn off</p> <p>• The LED (R) will light green when assigning buttons.</p>	<p><b>All settings will return to default.</b></p> <ul style="list-style-type: none"> <li>• Dead zone and sensitivity default values are set to "4".</li> <li>• When Quick Handling Mode is cancelled, steering wheel input value will default to 270°.</li> </ul>

• If you do not perform step ② after ①, the LED (R) will turn off after four seconds and setting mode will automatically end.

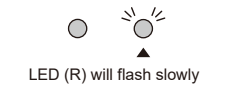
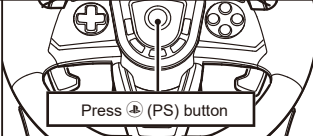
## How to Reset All Buttons

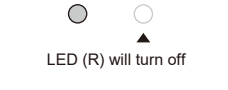
Operation	LED Status	Setting Status
①  Hold ASSIGN button for 3 seconds	 LED (R) will flash slowly	
②  Press  (PS) button	 LED (R) will turn off	<b>Reset All button Settings</b> All button assignments will reset to default settings.

## App [HORI Device Manager Vol.2]

Customize the racing wheel sensitivity, dead zone and other settings using the companion app. (PC required)

Profile / Button Mapping / Steering Radius Adjustment / Deadzone Adjustment / Steering Wheel Linearity / Pedal Linearity

## Download App

<https://stores.horiusa.com/spf-022U/app/>

Supported OS	Windows® 11 / 10
System Requirements	USB-A Port, Internet Connection

## Troubleshooting

### ① The product is not working

Please try the following methods.

- If the product does not respond when the buttons are pressed, it may be due to the low battery. Please fully charge the battery with the included USB cable and appropriate power source.
- If the buttons do not work immediately after connecting the steering wheel, please press the  (PS) button and set the steering wheel as the main controller for your profile

### ② The product is unable to charge, does not respond even when fully charged, or responds on its own without inputting

Please try the following steps.

1. Press the reset button on the back of the product with a thin stick or similar object (e.g. Paper clip). Do not use a sharp needle. Doing so may scratch or damage the product.
2. Reconnect ⇒ **p.8-9**

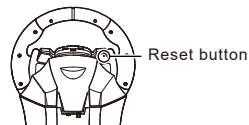

### ③ Cannot connect the DualSense® Wireless Controller / DUALSHOCK®4 Wireless Controller

Please power off the console and turn it on again.

## Regarding Wireless Interference

This product uses a 2.4 GHz radio frequency bandwidth. Wireless interference may occur if used at the same time as other wireless devices that also use 2.4 GHz radio frequency bandwidth, including the PS5® console.

Please do not use this product where wireless devices are prohibited or near electrical devices such as cardiac pacemakers, medical devices, fire alarms or other emergency equipment. Wireless signals may interfere with such devices and cause accidents.

## Regarding Battery

If the battery leaks, please do not touch the liquid or battery with your bare hands. Do not place this product near heat sources or leave in direct sunlight. Internal battery life may deplete over time.

- 
- Please be aware of the following during use and storage.
    - Do not place the product in or near fire.
    - Keep this product away from the following high temperature areas:
      - Near heaters, heat sources, or in direct sunlight.
      - Heated carpets or on top of home theater equipment.
      - Avoid using outdoors or inside a car during hot weather.
  - Do not charge this product other than by its specified method. The built-in battery may overheat or rupture which may cause a fire or malfunction.
  - Do not charge this product during a thunderstorm, as there may be risk of electric shock.
  - Keep USB connector away from metal objects. This may cause malfunction or electric shock.
  - Never disassemble, repair or modify this product. There is risk of fire, electric shock, battery rupture, or overheating.
  - Do not drop, step on, crush, or strike the product with strong force. This may cause fire, battery rupture, overheating, or electric shock.
  - Do not let liquid or foreign matter enter the product. It may cause fire, electric shock, or malfunction. If any liquid or foreign matter gets inside the product, stop using the product immediately and contact our customer support.
  - Keep the product away from water and do not use with wet or oily hands. It may cause electric shock or malfunction.
  - Keep the product away from humid, dusty, or smoky areas. It may cause electric shock or malfunction.
  - Keep the USB connector away from foreign matter or dust. It may cause electric shock, malfunction, or contact failure. Use a dry cloth to wipe off any foreign matter or dust.
  - Charge this product where the room temperature is 10 - 35°C (50 - 95°F). Charging outside this temperature range may result in the product not charging properly or prolong the charging time.
  - Please note that as with any rechargeable battery, the maximum amount of charge the battery can hold will gradually lessen over time after many charge cycles.
  - Recharge the battery at least once every three months to maintain function even if it has not been used for a prolonged time.



Li-ion 00

The Lithium Ion battery is made from recyclable resources.



# Specifications

## Steering Unit

External Dimensions : W 11 × D 10.8 × H 11.2 in  
/ W 28 × D 27.5 × H 28.6 cm

Steering Diameter : 11 in / 28 cm

Angle of Rotation : 270°

Weight : 3 lbs / 1.4 kg

Connection Method : 2.4 GHz Wireless Communication

Charging Time : 3 hours

Battery Life : Up to 10 hours

The usage time may be significantly shortened depending on the usage environment.

## Receiver

External Dimensions : W 1.3 × D 0.7 × H 0.3 in  
/ W 3.4 × D 1.7 × H 0.8 cm

Weight : 0.14 oz / 4 g

Connection Method : 2.4 GHz Wireless Communication

## Cable USB

Cable Length : 6.6 ft / 2 m

Connection Type : USB-A to USB-C™

## Foot Pedal

External Dimensions : W 8.8 × D 11.8 × H 5.9 in  
/ W 22.5 × D 30 × H 15 cm

Weight : 1.3 lbs / 0.6 kg

Cable Length : 6.6 ft / 2 m

### CAUTION:

Any changes or modifications not expressly approved by the party responsible for compliance could void the user's authority to operate the equipment.

### THE FCC WANTS YOU TO KNOW

This device complies with part 15 of the FCC Rules. Operation is subject to the following two conditions: (1) This device may not cause harmful interference, and (2) this device must accept any interference received, including interference that may cause undesired operation.

NOTE: This equipment has been tested and found to comply with the limits for a Class B digital device, pursuant to part 15 of the FCC Rules. These limits are designed to provide reasonable protection against harmful interference in a residential installation. This equipment generates, uses and can radiate radio frequency energy and, if not installed and used in accordance with the instructions, may cause harmful interference to radio communications. However, there is no guarantee that interference will not occur in a particular installation. If this equipment does cause harmful interference to radio or television reception, which can be determined by turning the equipment off and on, the user is encouraged to try to correct the interference by one or more of the following measures:

- Reorient or relocate the receiving antenna.
- Increase the separation between the equipment and receiver.
- Connect the equipment into an outlet on a circuit different from that to which the receiver is connected.
- Consult the dealer or an experienced radio/TV technician for help.

### RF exposure compliance

- 1) This equipment complies with FCC radiation exposure limits set forth for an uncontrolled environment.
- 2) This transmitter must not be co-located or operating in conjunction with any other antenna or transmitter.

### IC statement:

This device complies with Industry Canada Licence-exempt RSSs. Operation is subject to the following two conditions:

- (1) this device may not cause harmful interference, and
- (2) this device must accept any interference, including interference that may cause undesired operation of the device.

This equipment complies with Industry Canada radiation exposure limits set forth for an uncontrolled environment.

### CAN ICES-003(B) / NMB-003(B)

This Class B digital apparatus complies with Canadian ICES-003.

Cet appareil numérique de la classe B est conforme à la norme NMB-003 du Canada.

#### Simplified Declaration of Conformity

Hereby, HORI declares that this product is in compliance with Directive 2014/53/EU.

The full text of the EU declaration of conformity is available at the following internet address:

<https://hori.co.uk/consumer-information/>

For UK: Hereby, HORI declares that this product is in compliance with the relevant statutory requirements.

The full text of the declaration of conformity is available at the following internet address:

<https://hori.co.uk/consumer-information/>

#### PRODUCT DISPOSAL INFORMATION

Where you see this symbol on any of our electrical products or packaging, it indicates that the relevant electrical product or battery should not be disposed of as general household waste in Europe. To ensure the correct waste treatment of the product and battery, please dispose of them in accordance with any applicable local laws or requirements for disposal of electrical equipment or batteries. In so doing, you will help to conserve natural resources and improve standards of environmental protection in treatment and disposal of electrical waste.



HORI warrants to the original purchaser that our product purchased new in its original packaging shall be free of any defects in both material and workmanship for a period of one year from the original date of purchase. If the warranty claim cannot be processed through the original retailer, please contact HORI customer support.

For customer support in North America and Latin America, please use our customer support form:

<https://stores.horiusa.com/contact-us/>

For customer support in Europe, please email [info@horiuk.com](mailto:info@horiuk.com)

#### Warranty Information:

For North America, LATAM, Australia : <https://stores.horiusa.com/policies/>

For Europe & Middle East : <https://hori.co.uk/policies/>

Actual product may differ from image.

The manufacturer reserves the right to change the product design or specifications without notice.

“PS”, “PlayStation”, “PS5”, “PS4”, “DualSense”, and “DUALSHOCK” are registered trademarks or trademarks of Sony Interactive Entertainment Inc.

All other trademarks are the property of their respective owners.

Manufactured and distributed under license from Sony Interactive Entertainment Inc. or its affiliates.

USB-C is registered trademark of USB Implementers Forum.

HORI & HORI logo are registered trademarks of HORI.